

**Version 2010 / 01**

# **INTERNATIONAL MIRROR CLASS RULES**

**Authority\*: International Sailing Federation**



\* **The International Sailing Federation (ISAF) is not a National Authority (NA).**

## **PART A - ADMINISTRATIVE RULES**

### **1. GENERAL**

- 1.1 The Mirror is a One-Design Class Dinghy. The objective of the **Class Rules** is to ensure that Mirror Class dinghies are as nearly alike as possible with regard to any matter which may have influence on the basic speed or handling.
- 1.2 Whenever the words "**Class Rules**" are used, unless stated otherwise, they shall be taken as including these rules and diagrams, the approved plans and specification, and the **Measurement Form**. If a term appears in **bold** it is used in its defined sense in the ISAF Equipment Rules of Sailing
- 1.3 All Mirror Class dinghies shall be built and measured in accordance with the **Class Rules** and no alterations or additions are permitted unless specifically stated.
- 1.4 If the **official measurer** considers that there has been any attempt to depart from the design or the **Class Rules** in any particular, he shall report the matter to the ISAF Member National Authority or the International Mirror Class Association who shall consult the ISAF.
- 1.5 In the event of a discrepancy between these rules and the Measurement Form, the matter shall be referred to the ISAF.

### **2. AUTHORITY**

- 2.1 The authority for the class shall be the ISAF which shall co-operate with the International Mirror Class Association in all matters regarding these rules.
- 2.2 Any questions regarding these Rules shall be addressed to a National Mirror Class Association. In countries where there is no National Mirror Class Association questions may be put directly to the ISAF Member National Authority or the International Mirror Class Association.
- 2.3 Interpretation of these rules shall be made by the ISAF which shall consult the International Mirror Class Association. All such interpretations shall be submitted by 31st December next, to the IMCA membership for consideration of their incorporation into these Rules in accordance with the provisions of the IMCA Constitution.
- 2.4 The administering authority is the ISAF Member National Authority of the country of the owner. In countries where there is no ISAF Member National Authority or the ISAF Member National Authority does not wish to administer the class, its functions as stated in these rules shall be carried out by the International Mirror Class Association or its delegated representatives (National Mirror Class Associations).
- 2.5 Neither the ISAF, the International Mirror Class Association, a ISAF Member National Authority nor any National Mirror Class Association or **official measurer** are under any legal responsibility in respect of these rules or accuracy of measurement and no claim arising from them can be entertained.
- 2.6 The official language of the class is English and in the event of dispute over translation, the English text shall prevail.
- 2.7 The word "shall" is mandatory and the word "may" is permissive.

### **3. BUILDER**

- 3.1 The Mirror Class dinghy shall be built only by Kit Manufacturers, GRP Builders, and Professional Builders or Amateur Builders. For the purpose of these rules an Amateur Builder is one who builds not more than one Mirror Class Dinghy in any year.
- 3.2 New kit Manufacturers, GRP Builders and Professional Builders shall be licensed by ISAF (Jersey) Ltd. Licences may be issued after consultation with the ISAF Member National Authority and the National Mirror Class Association or International Mirror Class Association.
- 3.3 Licensed Kit Manufacturers shall be entitled to build Mirror Kits complying with the ISAF approved specification or complete Mirror dinghies.
- 3.4 Amateur or Professional Builders shall construct Mirrors only from kits supplied by Licensed Kit Manufacturers.
- 3.5 Only licensed GRP Builders shall build GRP Mirrors.
- 3.6 Kit Manufacturers, GRP Builders and Professional Builders shall be responsible for supplying complete boats complying with the **Class Rules**. The Builder shall, at his own expense, correct or replace any boat that does not comply with the **Class Rules** as a result of an omission or error by the builder, provided that the boat is submitted for measurement within twelve months of purchase.

### **4. INTERNATIONAL CLASS FEE**

- 4.1 The International Class Fee shall be paid by the Licensed Kit Manufacturer or GRP Builder on each hull as building commences or before each kit or GRP Mirror leaves the premises, whether or not the kit is subsequently completed by that manufacturer or another builder, and whether or not it is subsequently undergoes **fundamental measurement** and a **certificate** is issued.
- 4.2 The Kit Manufacturer or GRP Builder shall receive the ISAF Plaque (which serves as the International Class Fee Receipt) through Sailing International Ltd, Ariadne House, Town Quay, Southampton, SO14 2AQ, United Kingdom. The Plaque shall have on it the sail number for the dinghy and be fixed onto the inside face of the aft transom by the builder upon completion of construction. Only boats above sail number 69070 will be required to display an ISAF Plaque. Boats below number 69070 shall use the sail number on the Measurement Form.
- 4.3 The amount of the International Class Fee may be reviewed by the ISAF.

### **5. MEASUREMENT CERTIFICATE**

- 5.1 A Measurement **Certificate** is either:-
- a) an original, or certified true copy, of the Measurement Form which has been stamped by the **Certification Authority** or the National Mirror Class Association, or
  - b) A document in a form approved for this purpose by the ISAF and issued by the **Certification Authority** or the National Mirror Class Association
- 5.2 To obtain a Measurement Certificate the owner shall arrange for an **official measurer** to measure the boat and to check that the weight correctors, if any, are fitted. After the

Measurement Form has been properly completed and signed by the **official measurer** and the owner it shall be sent to the National Authority or the National Mirror Class Association who shall check and stamp the form and issue the Measurement Certificate.

5.3 The measurement **Certificate** is only valid when the owner is a current member of a National Mirror Class Association or, when there is no National Association in his nation, a member of the International Mirror Class Association.

5.4 Change of ownership invalidates the Measurement **Certificate**. The new owner shall return the original certificate to his ISAF Member National Authority or National Mirror Class Association who shall then re-validate it or issue a replacement Measurement **Certificate**.

## 6. **ENDORSEMENTS**

6.1 Before a boat is eligible to race the Measurement **Certificate** must have endorsements for-

(i) Buoyancy - The initial buoyancy test or inspection shall be carried out in accordance with Rule 4 by a **official measurer** approved under Administrative Rule 7. Subsequently annual buoyancy tests or inspections are required but these may be carried out either by a measurer or by any properly appointed Club Officer. Upon satisfactory completion of a buoyancy test or inspection under this Rule the **official measurer** or Club Officer shall sign and date the buoyancy section of the Measurement **Certificate**.

(ii) Sails - The owner shall have all sails to be used for racing measured in accordance with the **Class Rules**. On completion of satisfactory measurement the measurer shall sign and date the **sail** at its **tack**.

(iii) Weight - The boat shall be weighed in accordance with the **Class Rules** and on satisfactory completion the **official measurer** will sign and date the weight endorsement section of the **Measurement Certificate**. **Corrector weights** shall not be removed or changed without the dinghy being officially re-weighed and the **Measurement Certificate** endorsed.

## 7. **MEASUREMENT**

7.1 Only a measurer approved by the National Authority, National Mirror Class Association or the International Mirror Class Association shall measure a boat, her spars, sails and equipment and sign the declaration on the Measurement Form that they comply with the Class Rules.

7.2 Measurements shall be taken in accordance with the current ISAF Equipment Rules of Sailing unless otherwise specified in these rules.

7.3 A measurer shall not measure a boat, spars, sails or equipment owned, designed or built by the measurer, or in which the measurer is an interested party, or has a vested interest.

7.4 All boats, spars, sails and equipment shall be liable to re-measurement at the discretion of a National Authority or Race Committee, but only by an approved measurer.

7.5 Alterations, replacements or repairs to all boats shall comply with the current Class Rules and where the replacement of hull panels is required, shall be carried out using only such panels originally supplied by a licensed kit manufacturer. Part B, Rule 1.1.2 shall apply to any modification of parts used for alteration, replacement or repair. If a boat has been repaired or

re-built to an extent which exceeds one third of the hull it shall be re-measured in accordance with the current Class Rules.

- 7.6 All boats, spars, sails and equipment shall comply with the current Class Rules and relevant Racing Rules of Sailing at all times unless otherwise specified in these rules.
- 7.7 Notwithstanding anything contained herein, the National Authority has the right to refuse to grant or withdraw a Measurement Certificate and/or endorsements. Owners are to return their Measurement Certificates to the National Authority or National Mirror Class Association upon request.

## **PART B - MEASUREMENT RULES**

### **1. HULL**

#### **1.1 Construction Materials**

- 1.1.1 The Licensed Kit Manufacturer shall complete hulls using only wood, plywood, glassfibre tape, resin and adhesives to the ISAF specification.
- 1.1.2 Amateur and Professional Builders shall complete hulls using only materials supplied with the Mirror kits (except for adhesives which are optional) and shall not modify or replace any part of the kit except where specifically permitted by these Rules.
- 1.1.3 GRP Builders shall complete hulls using only materials prescribed in the ISAF GRP Building Specification.
- 1.1.4 Finishes are optional but they shall not be reinforced except where permitted in these rules.

#### **1.2 Construction**

- 1.2.1 All the panels and wood parts supplied with the kit shall be incorporated into the hull with the exception of the forward shroud blocks, jib fairleads and forward mast step which are optional. All wood parts shall be used only for their intended purpose. Where these Rules provide that the material of a part is optional the supplied wood part may be replaced by an equivalent part of the alternative material.
- 1.2.2 The shell of the wooden hulls shall be constructed using the 'stitch and glue' method of construction and all hull joints so constructed shall be reinforced with at least one layer of the glass fibre tape supplied with the kit on both the inside and the outside of the joint. Joints between other kit panels, shall be reinforced with at least one layer of the glass fibre tape supplied with the kit.
- 1.2.3 GRP hulls shall be constructed in accordance with the ISAF GRP Building Specification.

#### **1.3 Measurement Definitions**

- 1.3.1 Chine - The chine is defined by the intersection of the extensions of the outside faces of the bottom and side panels, and shall be fair.
- 1.3.2 Not in use.
- 1.3.3 Hull Datum Point – The lowest point on the aft transom where the extension of the bottom panels meet on the centreline
- 1.3.4 Forward Measurement Point - The Forward Measurement Point is defined by the intersection of the outside surface of the keelband on the centreline and the extension of the face of the bow transom.
- 1.3.5 Measurement Sections - The Measurement Sections shall be defined by the following points measured from the aft face of the aft transom along the hull centrelines, chines and sheerlines immediately below the outer gunwales.

SECTION	HULL CENTRELINE mm	CHINE mm	SHEERLINE mm
0	0	0	0
1	700	700	705
2	1400	1400	1400
3	2135	2140	2135
4	2460	2470	2465

#### 1.4 Hull Shape

1.4.1 The distance from the base line conforming with the diagram to the keelband on the centreline shall be within  $\pm 10\text{mm}$  of the measurements below measured perpendicular to the base line:

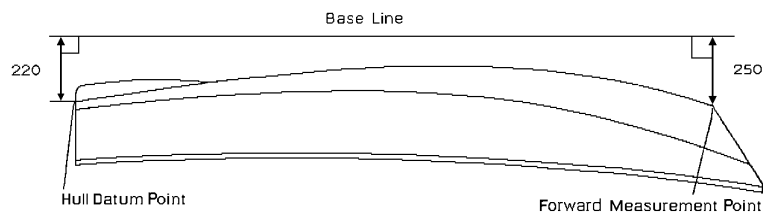

SECTION	mm
1	108
2	38
3	44
4	76

1.4.2 No point on the centreline of the aft face of the aft transom shall be more than 10mm from a line through the **Hull Datum Point**, perpendicular to the base line.

1.4.3 The hull sections shall conform with the diagram and table below where:

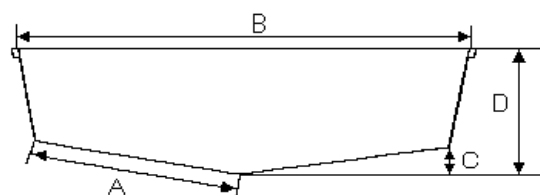

- A is the width of each bottom panel from the hull centreline to the chine.
- B is the beam at the **sheerline**.

- C is the distance from a horizontal line touching the keelband to the chine, except for section 0 where the horizontal line shall pass through the **Hull Datum Point**.
- D is the distance from a horizontal line touching the keelband to the sheerline except for section 0 where the horizontal line shall pass through the **Hull Datum Point**.

SECTION	A mm	B mm	C mm	D mm
0	480	1063	60	312
1	578	1284	70	418
2	614	1382	120	499
3	595	1296	203	525
4	563	1172	240	520

Measurement A at each section, tolerance =  $\pm 8$ mm

Measurement C at Section 0, tolerance =  $\pm 8$ mm

Measurement B at each section (except section 0) tolerance =  $\pm 20$ mm

Measurement D at each section (except section 0) tolerance =  $\pm 15$ mm

All other measurements, tolerance =  $\pm 10$ mm

- 1.4.4 The distance measured around the outside of the hull shell adjacent to the keelband, from the Forward Measurement Point to the **Hull Datum Point** shall be 3088mm  $\pm 10$ mm.
- 1.4.5 The distance from the centre of the top of the bow shapes in line with the bow transom to the Forward Measurement Point measured along the face of the bow transom shall be 520mm  $\pm 10$ mm.
- 1.4.6 The minimum beam of the bow transom measured along or parallel to the face of the transom shall conform to the following table.

DISTANCE FROM FORWARD MEASUREMENT POINT	BEAM
275 mm	405 mm
475 mm	550 mm

Boats with sail numbers lower than 69931 and constructed and certified on or before June 30 1998 shall have a beam at the top measurement point of not less than 500mm.

- 1.4.7 The athwartships curvature of the bottom panels between points set 50mm inboard from the chine and 50mm outboard from the centreline shall conform with the table (positive for convex curve).



SECTION	CURVATURE
0	6mm ± 3mm
1	0mm ± 3mm
2	8mm ± 5mm
3	8mm ± 5mm

1.4.8 Between sections 0 and 3, the radius of the chines shall be not more than 10mm.

1.4.9 The **bilge keels** shall conform with the diagram. They shall be not less than 13mm in width and not less than 9mm depth for a length of not less than 915mm.

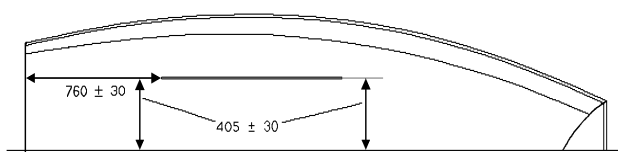

1.4.10 The **skeg** shall conform with the diagram. The dimensions shall include the keelband. The overall length shall be not less than 635mm and the thickness at the hull not less than 18mm. The hole in the **skeg** is optional. If it exists it, and all associated fairing around it, shall be contained within a rectangle measuring a maximum of 202mm long and a maximum of 73mm deep. The hole shall be a minimum of 10mm from the hull or the surface of the keelband.

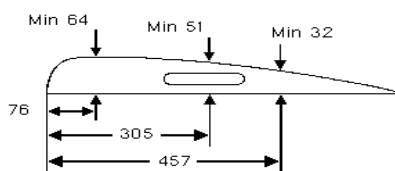

1.4.11 The **daggerboard** case shall conform with the diagram. The height of the **daggerboard** case shall be measured from the underside of the outside hull shell, including keelbands, at the aft and forward edges of the **daggerboard** slot. Except for the first 5mm at each end, the width of the **daggerboard** slot shall be 15mm +/- 4mm and the width may not vary by more than 2mm. The projection of the **daggerboard** when fully down, below keelband, shall be not more than 610mm. With the **daggerboard** in the normal sailing position the leading edge shall slope by not more than 1 in 20 from perpendicular to the baseline.

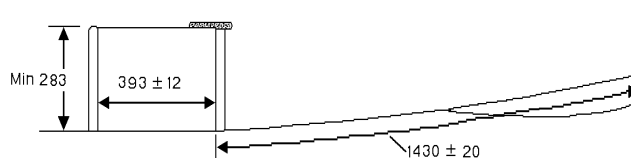

1.4.12 The outer gunwales shall be 15mm ± 3mm in width measured perpendicular to the side panels. The depth of the outer gunwales measured from the sheerline parallel to the side panels shall be 28mm ± 3mm except within 500mm of the bow where the depth may be reduced to not less than 20mm. The radius of the gunwale edges of wooden gunwales shall be not more than 15mm. The minimum dimensions in this rule shall not apply to GRP gunwales.

- 1.4.13 The stem post shall be not less than 200mm long and not less than 15mm thick. The stem post may be omitted on GRP boats.
- 1.4.14 Holes may be through the aft transom as follows:-
- Two drain holes above the aft deck each of which shall be capable of being contained within a rectangle not more than 40mm in height and not more than 100mm in width.
- Two drainage holes into the aft buoyancy tank.
- One hole of not more than 18mm diameter for the attachment of the mainsheet, no part of which shall be more than 50mm below the top edge of the transom.
- 1.4.15 There shall be no holes passing through the hull shell other than for the **daggerboard**, the transom drain holes, the transom drainage holes, mainsheet hole, rowlock drain holes on Mark 1 boats, suction bailers and fixings.
- 1.5 **Outside Hull Fittings**
- 1.5.1 A keel-band of non-ferrous metal, D-shaped or rectangular in cross section and a minimum of 2mm and a maximum of 4.5mm deep on its centreline and not less than 11 wide, shall be fitted to the outside of the hull:
- (i) From a point on the bow transom not less than 20mm from the Forward Measurement Point along the hull centreline to the forward end of the **daggerboard** slot;
  - (ii) On each side of the **daggerboard** slot with the inner edges of the band not more than 25mm from the hull centreline;
  - (iii) From the aft end of the **daggerboard** slot, along the hull centreline and along the underside and aft edge of the **skeg** to within 10mm of the **Hull Datum Point**.
- On GRP boats the keel-band may be of GRP in which case it shall be formed by the hull moulding.
- 1.5.2 Two **rudder** pivot fittings shall be fitted on the aft transom the bearing surfaces of which shall be not less than 200mm apart. One **rudder** retaining device shall be fitted.
- 1.5.3 A towing eye may be fitted to the stem post or bow transom.
- 1.5.4 Not more than two suction bailers may be fitted.
- 1.5.5 Backing plates may be fitted for the shroud attachments.  
Backing plates of wood or other materials are permitted provided that they are used solely to improve the security and or strength of the fittings mounted on them. They may be placed either inside or outside the wooden panels but they may not be mounted on the outside of the hull, except where this is specifically provided in the rules.
- 1.5.6 Two spinnaker reaching hooks and two cleats, all with optional backing plates, may be fitted to the outer gunwale. No point on these fittings may be outboard of a vertical line touching the closest point on the outside surface of the outer gunwale to the point on the fitting.
- 1.5.7 Two attachment points with optional backing plates for capsized recovery lines may be fitted to the underside of the outer gunwale. No point on these fittings may be outboard of a vertical line touching the closest point on the outside surface of the outer gunwale to the point on the fitting.

- 1.5.8 A maximum of two drainage holes of diameter minimum 10mm, maximum 20mm, from the transom into the aft buoyancy tank. These holes to be fitted with caps with a positive locking mechanism.
- 1.5.9 No other fittings shall be fitted to the outside of the hull forward of the aft face of the aft transom.
- 1.5.10 No other fittings shall be fitted to the outside of the hull forward of the aft face of the aft transom.

## 1.6 **Internal Details**

Three interior designs are permitted. These are defined as follows;

- 1.6.0.1 The Mark 1 interior design has no stowage compartments, no drip rail, no inner gunwales (though these may have been added later), the thickened transom did not extend to deck level and there were knees from the side decks to side panels at the rowlocks and pads under the shroud blocks. This design was used on wooden boats with sail numbers 1 to 700.
- 1.6.0.2 The Mark 2 interior design has stowage compartments, a drip rail, inner gunwales, the thickened transom extends to deck level. There are no knees to support the rowlocks and no pads under the shroud blocks. This design was used on wooden boats with sail numbers above 701.
- 1.6.0.3 The Mark 3 interior was designed in 2006 for GRP construction. This design has no stowage compartments (but may have stowage options, such as bins, in the stowage bulkhead), no drip rail, wrap over gunwales, no stem post or shroud blocks, dished fore and aft decks, raised area on foredeck for mast step.
- 1.6.0.4 On a Mark 1, measurements to the "forward face of the aft transom" shall be taken to mean the forward face of the aft transom which is 50mm or more above deck level and then projected as necessary.

### 1.6.1 **Rules applying to all three interiors**

- 1.6.1.1 The length overall measured from the aft face of the aft transom at **sheerline** to the foremost face of the rubbing strake shall be a minimum of 3285 mm and a maximum of 3325 mm.
- 1.6.1.2 The forward face of the aft bulkhead shall be a minimum of 395 mm and a maximum of 455 mm from the forward face of the aft transom unit measured along the centreline at deck level.
- 1.6.1.3 The aft face of the stowage compartment bulkhead shall be a minimum of 2085 mm and a maximum of 2115 mm from the forward face of the aft transom unit measured along the centreline at deck level.
- 1.6.1.4 The distance between the faces of the side tank panels at the forward face of the aft bulkhead shall be a minimum of 735 mm and a maximum of 765 mm.
- 1.6.1.5 The distance between the faces of the side tank panels at the aft face of the stowage compartment bulkhead shall be a minimum of 735 mm and a maximum of 775 mm.
- 1.6.1.6 The thwart shall be not less than 142 mm in fore and aft width and not less than 13mm nor more than 17 mm thick. The thickness dimension shall not apply to GRP thwarts. The thwart shall extend the full width between each side tank panel over and permanently fixed to the top of the **daggerboard** case. A slot on the hull centreline of not more than 19 mm in width shall be cut into the thwart. The distance from the aft edge of the thwart

to the forward face of the aft transom unit at deckline shall be a minimum of 1315 mm and a maximum of 1365 mm . The transverse width of the thwart shall be a minimum of 805 mm and a maximum of 835 mm.

- 1.6.1.7 An inspection hatch of a minimum of 130 mm and a maximum of 170 mm in internal diameter shall be fitted to the forward buoyancy tank in either the foredeck or forward bulkhead of a Mark 2, or the stowage bulkhead of a Mark 1 or a Mark 3. The aft bulkhead and the side tank panels may each have one inspection hatch of not more than 170mm in diameter. All inspection hatches shall be fitted with a watertight cover while racing.
- 1.6.1.8 There shall be one drain hole of diameter a minimum of 10mm and a maximum of 20mm in the aft bulkhead and each side tank panel and two drain holes of diameter a minimum of 10mm and a maximum of 20mm in the forward bulkhead and the stowage compartment bulkhead. The drain hole, or holes, may be omitted on a tank that is fitted with an inspection hatch. All drain holes other than those in the stowage compartment bulkhead shall be closed while racing. The requirement for drain holes in the forward bulkhead does not apply to Mark 1 and Mark 3 boats. The minimum size does not apply to drain holes on Mark 1 boats.
- 1.6.1.9 The floor battens shall each be a minimum of 1615 mm and a maximum of 1635 mm long. They shall be fixed to the cockpit well floor with two either side of the hull centreline. A third pair of battens, with dimensions no greater than those of the others, may be fitted, one on each side of the hull centreline. Battens shall be placed between the aft and the stowage bulkheads. Boats with sail numbers less than 68,000 may have shorter battens and may have only one batten per side. Floor battens may be omitted on GRP boats.
- 1.6.1.10 The material of the mast step is optional. The top surface of the mast step shall be not more than 12 mm above the top surface of the foredeck butt strap or, on a Mark 3, the mast step mounting surface. A drain hole not exceeding 6mm diameter is permitted in the mast step.
- For boats equipped with a gunter rig the following shall apply. The centre of the mast step shall be minimum 2145 mm and maximum 2175 mm forward of the forward face of the aft transom at deck level.
- For boats equipped with a Bermuda rig the following shall apply. The Intersection of the fore side of the **spar** and surface of the foredeck butt strap or the mast step mounting surface shall be maximum 2145 mm and maximum 2175 mm forward of the forward face of the aft transom at deck level.
- An optional second mast step may be fitted outside of the above tolerances but shall not be used while *racing*.
- 1.6.1.11 The shortest distance from the aft face of the aft transom to the forward face of the aft transom above deck level shall be a minimum of 22 mm and a maximum of 28mm.
- 1.6.1.12 There shall be no holes through the internal structures and decking other than for fixings, except for the footrest which may have one drainhole and the mast step which may have a drainhole of not more than 6mm diameter in the aft edge. The footrest may be omitted on GRP boats.
- 1.6.1.13 A bulkhead or strut of plywood or wood may be fitted in each side tank in the vicinity of the thwart.

## 1.6.2 **Additional rules applying to the mark 1 interior only**

- 1.6.2.1 The depth of the side tank panels shall be a minimum of 200 mm and a maximum of 230 mm at the forward face of the aft bulkhead and a minimum of 260 mm and a maximum of 290 mm at the aft face of the stowage compartment bulkhead.
- 1.6.2.2 The deck level at all sections shall be a minimum of 100 mm and a maximum of 130 mm below the sheerline.
- 1.6.2.3 If inner gunwales are fitted, they should comply with rule 1.6.3.4

## 1.6.3 **Additional rules applying to the mark 2 interior only;**

- 1.6.3.1 The aft face of the forward bulkhead shall be a minimum of 300 mm and a maximum of 340 mm forward of the aft face of the stowage compartment bulkhead.
- 1.6.3.2 Rule 1.6.2.1 shall apply.
- 1.6.3.3 Rule 1.6.2.2 shall apply.
- 1.6.3.4 The inner gunwales shall be a minimum of 17 mm and a maximum of 23 mm in width measured perpendicular to the side panels. The depth of the inner gunwales measured from **sheerline** parallel to the side panels shall be a minimum of 25 mm and a maximum of 31 mm except for within 500 mm of the bow where the depth may be reduced to not less than 20 mm. The radius of the gunwale edges shall be not more than 15 mm. The minimum dimensions in this rule shall not apply to GRP gunwales.
- 1.6.3.5 On GRP boats the material of the drip rail is optional.
- 1.6.3.6 A chamfer is allowed at the junction of the side tank panel and the deck panel for the mounting of cleats for control lines. This to be a maximum of 200 mm long and 30 mm from the corner of the tank, across the tank top and down the side panel. If chamfers are fitted, a timber reinforcement block shall be fitted under the chamfers. On wooden hulls the chamfers shall be covered by glass fibre tape. Only one chamfer is allowed on each side tank.

## 1.6.4 **The following rules apply to the mark 3 interior only;**

- 1.6.4.1 The deck level at all sections shall be a minimum of 100 mm and a maximum of 224 mm below the sheerline. The mast step mounting surface shall be a minimum of 95 mm and a maximum of 125 mm below the sheerline.

## 1.7 **Internal Fittings**

- 1.7.1 The shroud attachment fittings shall be a minimum of 1798 mm and a maximum of 1848 mm forward of the aft face of the aft transom measured parallel to the centreline. An optional second set of shroud attachment points may be fitted outside the above tolerances but shall not be used while *racing*.
- 1.7.2 The forestay attachment fitting shall be permanently fixed to the centreline on the inside face of the bow transom above deck level.
- 1.7.3 There shall be not more than one port and one starboard jib sheet fairlead the position of which shall not be adjustable. Roller fairleads are not permitted. Jib sheet jam cleats may be fitted. The fairleads and associated jam cleats shall be fitted either on the gunwales, the top of the decking or the top of the thwart. If mounting blocks are used they shall be not more than 25mm thick nor more than 150mm in length or breadth and shall not overhang the deck

edge or thwart. If backing plates are used, the size is optional, but they shall only be used for their intended purpose.

1.7.4 The tack of the jib may be secured so that it can be adjusted while racing provided that no mechanical advantage is gained by the adjustment.

1.7.5

	Minimum	Maximum
The distance between the centres of the mainsheet attachment points on the transom	450mm	500mm

1.7.6 Other internal fittings are optional subject to any further limitations or prohibitions within these rules.

## 1.8 **Weight**

1.8.1 Boats shall be weighed with the internal and external surfaces in a dry condition. The initial weighing shall be done before the boat is launched for the first time or after the boat has been kept out of the water in a dry condition with drain holes and hatch covers removed for at least 14 days.

1.8.2 The weight of the hull including correctors, if fitted, shall be not less than 45.5kg. This weight includes all essential fixed fittings which are normally those screwed, glued or bolted in place but excluding centreboard, rudder, tiller, sails, spars, compasses and all other removable and non-essential items.

1.8.3 **Corrector weights** may be fitted and shall be of lead fixed to the underside of the thwart. Boats with corrector weights on the forward face of the aft bulkhead have until 1<sup>st</sup> December 2008 to change the location of their corrector weights. **Corrector weights** shall be permanently marked with their weight in Arabic numerals of not less than 15mm in height. The total weight of the **correctors weights** for boats first certificated after the 1<sup>st</sup> September 1997 shall not be more than 3kg. The number of and weight of each **corrector weight**, if fitted, shall be recorded on the **measurement certificate**.

1.8.4 **Corrector weights** shall not be moved or altered unless the boat is re-weighed in a dry condition by an **official measurer** who shall record the revised weight on the **Measurement Certificate** and sign it. The **certificate** shall be sent to the National Authority or National Mirror Class Association, which shall endorse the certificate and return it to the owner.

## 2. **DAGGERBOARD**

2.1 The **daggerboard** shall be of solid or laminated wood. The material of finishes is optional, and it may be sheathed with GRP, but shall not be otherwise reinforced. When a **daggerboard** is sheathed it must still be capable of floating unaided in fresh water.

2.2 The **daggerboard** shall conform with the diagram. The **daggerboard** shall be not more than 14mm thick and the thickness shall not vary by more than 1mm to within 50mm of its edges with the exception of hollows or cavities of not more than 2mm in dimension. The leading, trailing and bottom edges of the **daggerboard** shall be within 5mm of a straight line and the leading and trailing edges shall be parallel within a tolerance of 10mm. Brass or other metal protection strips are not allowed.

2.3 A handle of tape or rope may be fitted.

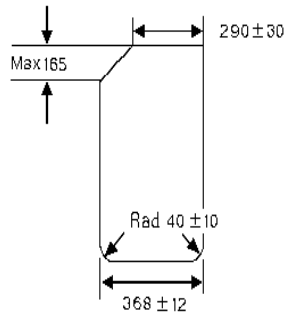

### 3. **RUDDER**

- 3.1 The **rudder** stock shall be of wood, aluminium alloy or GRP construction and may include plastic and stainless steel components. The weight of the **rudder** stock, including tiller and fittings but excluding tiller extension, **rudder** blade and pivot bolt shall not be less than 0.9kg. The **rudder** blade shall be of wood and may be sheathed in GRP but shall not be otherwise reinforced. The **rudder** assembly, comprising of the **rudder** stock, **rudder** blade, tiller, tiller extension, pivot bolt and fittings shall be capable of floating in fresh water.

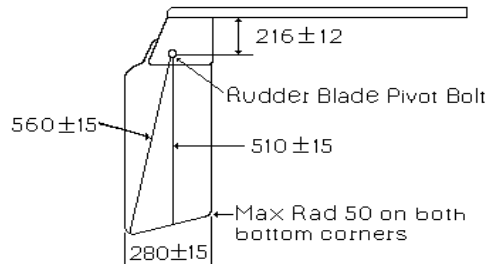

- 3.2 The dimensions of the **rudder** blade shall conform with the diagram. The **rudder** blade shall be not more than 14mm thick and the thickness shall not vary by more than 1mm to within 25mm of its edges with the exception of hollows or cavities of not more than 2mm in dimension and holes for fixing.

The centre of the pivot bolt hole shall be between 204mm and 228mm below the intersection of the lowest point of the underside of the tiller and the leading edge of the stock.

- 3.3 The material of the tiller and method of fixing to the **rudder** are optional.
- 3.4 The **rudder** blade shall be capable of rotating around the pivot; however, the leading edge shall not be capable of be moved forward of vertical, and when in the fully lowered position a point on the leading edge shall remain within 70mm of a vertical line through the **Hull Datum Point**.
- 3.5 The fitting of washers between the **rudder** blade and the **rudder** stock is permitted.

#### 4. **BUOYANCY TANKS, TEST & INSPECTION**

- 4.1 Buoyancy tanks shall be formed by the decking, the bulkheads, the side tank panels and the hull shell. The following buoyancy tank configurations are permitted;
- i) 4 separate tanks, these being the stern tank, two side tanks and a bow tank.
  - ii) 2 separate tanks, these being a combined stern and sides tank and a bow tank.
  - iii) 1 single tank, being a combined stern, sides and bow tank containing foam in accordance with the GRP specification.
- 4.2 Each buoyancy tank shall be individually tested and inspected in accordance with Administrative rule 6.1(i) using the following procedure:

The buoyancy tank hatches shall be closed normally and draining holes shall be closed with their normal stoppers except where tubes to a pressure source and gauge are connected. Equipment for producing a pressure differential between the buoyancy tank and the surrounding atmosphere and a U-tube water gauge for measuring the differential shall then be connected to the tank. Air pressure shall be applied to the tank sufficient to produce a differential reading of at least 100mm on the water gauge. After isolating the buoyancy tank from the pressure source, the pressure differential shall not decrease from 100mm to 50mm in less than 20 seconds.

After completing the tests and carefully checking that the condition and fastenings of all the buoyancy tanks are sound the **official measurer** or Club Officer may, at his discretion, sign the buoyancy endorsement on the **Measurement Form** or **Measurement Certificate**.

#### 5. **SPARS**

Boats may have a gunter rig, comprising a gunter mast and a gaff, or a Bermuda rig, comprising a Bermuda mast. Only one of these rig configurations may be used in any one event of less than 14 consecutive days duration.

##### 5.1 **Gunter Mast**

- 5.1.1 The overall length of the **mast**, including end fittings, if fitted, shall be not more than 3296mm.
- 5.1.2 The **mast** may be of solid unlaminated wood or aluminium alloy tube with wood end plugs.
- 5.1.3 The **mast** shall be circular in cross section between a point 50mm from the bottom end and a point 130mm from the top end, except that hollows or cavities not more than 2mm deep shall not be considered an infringing of this rule.
- 5.1.4 The diameter of a wood **mast** shall be 50mm  $\pm$  6mm and the diameter of an aluminium alloy **mast** shall be 50mm  $\pm$  3mm.
- 5.1.5 The mainsail halyard sheave shall be contained entirely within a slot cut in the centre of the **mast** and the distance between the bottom of the **mast** and the bearing surface of the sheave shall be not more than 3200mm.
- 5.1.6 The distance between the bottom end of the **mast** and the top edge of the boom shall be 669mm  $\pm$  10mm.



- 5.1.7 The weight of the **mast** including fixed fittings shall be not less than 2.7kgs.
- 5.1.8 The aft side of the **mast** shall be straight. A permanent set of not more than 15mm shall not be considered to infringe this rule.
- 5.1.9 The peg on the bottom of the **mast** shall be on the centre line of the **mast** and it shall not be possible for the peg to move in the mast step by more than 2mm in any direction when the **mast** is raised
- 5.1.10 The spinnaker pole fitting shall project not more than 35mm.
- 5.1.11 Rigging may not be run inside the **mast**.

## 5.2 **Main Boom**

- 5.2.1 The overall length of the boom **spar**, excluding fittings, shall be minimum 2235 mm and maximum 2285 mm.
- 5.2.2 The boom **spar** shall be either of solid unlaminated wood or of aluminium alloy extrusion from the International Alloy Designation System (IADS) 6000 series. Within 200 mm of its forward end the wooden boom may be reinforced with GRP. The finish of the alloy **spar** shall be by anodizing, painting, powder coating or waxing. The finish of the wood **spar** may be by painting, resin coated, varnishing or waxed.
- 5.2.3 The aluminium alloy **spar** shall be of constant section throughout its length with a maximum **boom spar cross section** measured **vertically** or **transversely** of 51 mm. The aluminium alloy **spar** extrusion may have integral spar groves. Except for within 100 mm of its forward the wooden **spar** shall be of constant section throughout its length with a **boom spar cross section** measured **vertically** or **transversely** of a minimum 37 mm and maximum 43 mm
- 5.2.4 No fitting shall be attached to the side of the wooden **spar** aft of the kicking strap attachment point. The aluminium alloy **spar** may be rigged internally.
- 5.2.5 A clew outhaul track may be recessed flush to the top of the wood boom.

## 5.3 **Gaff**

- 5.3.1 The overall length of the gaff measured along the luff groove shall be not more than 2809mm.
- 5.3.2 The gaff shall be solid wood or laminated from two (paired) pieces of wood.
- 5.3.3 The circumference (girth) of the gaff shall be not less than:

at the top end	102mm
at the point 204mm from the lower end, measured along the luff groove	127mm
at the gaff band	146mm

The gaff shall be uniformly tapered from the gaff band to the peak. No section of the gaff shall exceed 45mm in the fore and aft or the thwartships directions except over the cheeks of the jaws.

5.3.4 The luff groove face of the gaff shall be straight. A permanent set of 15mm shall not be considered to infringe this rule.

5.3.5 A distinctive coloured measurement band of not less than 16mm in width shall be painted on the gaff so that the lower edge of the band is not less than 76mm from the top of the gaff.

5.3.6 The mainsail halyard shall be attached to the gaff by an attachment band or by an attachment pin through a slot in the gaff. The bottom of the mainsail halyard attachment band or pin shall be not more than 1733mm below the top of the gaff.

5.3.7 Hollows in the gaff in way of the mast are not permitted.

#### 5.4 Spinnaker pole and Jib Stick

5.4.1 The overall length of the spinnaker pole and jib stick, including end fittings, if any, shall each be not more than 1524mm. The cross section dimensions and fittings are optional.

5.4.2 The spinnaker pole and jib stick if carried, shall be of wood or aluminium tube.

#### 5.5 Bermuda Mast

5.5.1 Measurements shall be taken according to the ISAF Equipment Rules of Sailing (ERS) unless specified. When a term is used in its **defined** sense, it is printed in "*italic*" type if defined in the ISAF Racing Rules of Sailing (RSS) and in "**bold**" type if defined in the ERS. ERS part 1 section B.7 and B.9 shall apply.

5.5.2 The **mast datum point** is the **heel point**.

5.5.3 The mast heel tenon is the tenon, the lowest point of which forms the **heel point**, used to locate the mast in the mast step.

5.5.4 The mast heel tenon shoulder is the surface surrounding the mast heel tenon as defined in 5.5.3. which bears, or could bear, on the top surface of the mast step.

5.5.5 The mast heel tenon shoulder height is the shortest distance from any point on the mast heel tenon shoulder to the **heel point**.

5.5.6 The mast taper point is the point on the front face of the **spar**, below which the section of the **mast spar** extrusion is constant, apart from section changes resulting from any join mechanism.

5.5.7 The mast taper point height is the distance between the **mast datum point** and the mast taper point as defined in 5.5.6.

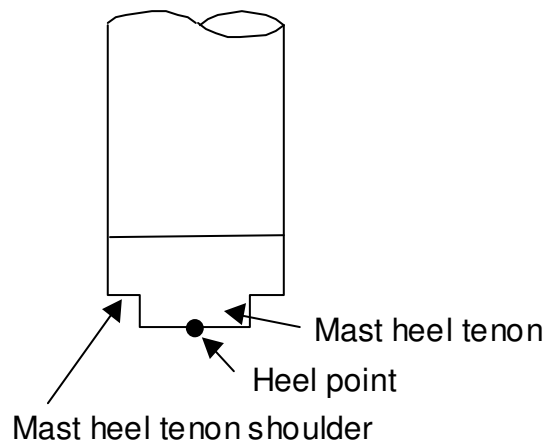

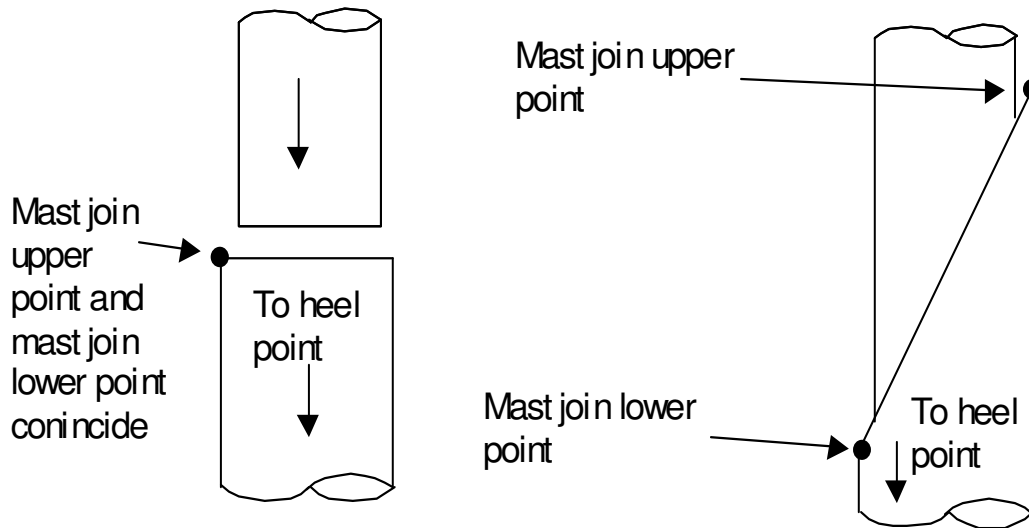

- 5.5.9 The mast join lower point is the lowest point on the outside surface of the lower section of the **mast spar** at the join.
- 5.5.10 The mast join upper point is the highest point on the outside surface of the lower section of the **mast spar** at the join
- 5.5.11 The mast join lower point height is the distance between the **mast datum point** and the mast join lower point as defined in 5.5.9.
- 5.5.12 The mast join upper point height is the distance between the **mast datum point** and the mast join upper point as defined in 5.5.10.
- 5.5.14 The mast join reinforcement length is the distance between lowest point and the highest point on the join reinforcement.
- 5.5.15 Spinnaker hoist fitting projection shall be measured as the shortest distance between the outermost point on any fitting over or through which the spinnaker halyard runs at the **spinnaker hoist height**, and the **spar** with the halyard at 90 degrees to the **spar** and extended as necessary.
- 5.5.16 The **spar** shall be of aluminium alloy extrusion from the International Alloy Designation System (IADS) 6000 series. The finish of the alloy **spar** may be by anodizing, painting, powder coating or waxing.
- 5.5.17 The **spar** shall include a fixed sail groove which may or may not be integral with the **spar** extrusion. Sail grooves that are not part of the **spar** extrusion may be of aluminium alloy extrusion from the International Alloy Designation System (IADS) 6000 series, or plastic.
- 5.5.18 The **spar** may be capable of being disassembled into two pieces. The method of joining a two piece **spar** is optional. The dimensions Mast join lower point height, Mast join upper point height and Mast join reinforcement length only apply to a two piece **spar**.

5.5.19 The spar shall carry a serial number assigned by the manufacturer or the measurer.

#### 5.5.20 Fittings

- (a) MANDATORY
  - (1) Shroud and forestay tangs, eyes, or hook terminal backing plates.
  - (2) Mainsail halyard sheave box, eye or a mast head fitting incorporating a sheave.
  - (3) Gooseneck.
  - (4) Heel fitting, which may incorporate sheaves for halyards and control lines.
  - (5) Main halyard cleat, hook or tooth rack.
  - (6) Jib halyard cleat, hook or tooth rack.
  
- (b) OPTIONAL
  - (1) Jib halyard block with attachment, or sheave box.
  - (2) Spinnaker halyard block with attachment, or sheave box.
  - (3) Spinnaker halyard crane.
  - (4) Spinnaker pole fittings.
  - (5) Spinnaker pole lift block with attachment, sheave box, or lift eye, or lift eyes.
  - (6) Spinnaker pole downhaul block with attachment or eye.
  - (7) Exit sheaves or exit slot fittings for halyards and control lines.
  - (8) Sail groove feeder.
  - (9) Mainsail tack downhaul cleat.
  - (10) Spinnaker halyard cleat.
  - (11) Spinnaker lift cleat.
  - (12) Spinnaker pole deployment line (fly-away pole) cleat.
  - (13) End cap.
  - (14) Mechanical wind indicator fixing.
  - (15) Spar join mechanism.
  - (16) Kicking strap and attachment fitting.
  - (17) Compass bracket.
  - (18) Gnav strut including attachment fittings.
  - (19) Mast sleeve

5.5.21 The **spar** shall be stepped in the mast step in such a way that the heel is not be capable of moving more than 2mm or rotating such that any point on the outside surface of the **spar** moves more than 2mm.

#### 5.5.22 Dimensions

	Minimum	Maximum
<b>Mast spar curvature</b>		30 mm
<b>Mast spar cross section</b> 1700 mm above the <b>mast datum point</b>		
<b>fore-and-aft</b>	47 mm	70 mm
<b>transverse</b>	47 mm	70 mm
<b>Mast spar cross section</b> 4857mm above the <b>mast datum point</b>		
<b>fore-and-aft</b>	25 mm	70 mm
<b>transverse</b>	25 mm	70 mm
<b>Mast limit mark width</b>	10 mm	
<b>Lower point height</b>	659 mm	
<b>Upper point height</b>		4857 mm
Mast taper point height as defined in 5.5.7	3193 mm	
Mast heel tenon shoulder height as defined in 5.5.5	8 mm	12 mm
Mast join lower point height as defined in 5.5.11	2893 mm	

Mast join upper point height as defined in 5.5.12		3493 mm
Mast join reinforcement length as defined in 5.5.14		650 mm
<b>Forestay height</b>	3173 mm	3193 mm
<b>Shroud height</b>	3173 mm	3193 mm
<b>Spinnaker hoist height</b>		3283 mm
Spinnaker host fitting projection		90mm
Spinnaker pole fitting projection		35mm

#### 5.5.22 WEIGHTS

	Minimum	Maximum
<b>Spar weight</b>	3.7Kg	

## 6. **RIGGING**

### 6.1 **Standing Rigging**

6.1.1 Only the following standing rigging of wire rope not less than 2mm diameter shall be fitted:

- One forestay
- Two shrouds
- One jib halyard strop

Boats with bermuda masts may omit the jib halyard strop. All standing rigging shall be attached to the gunter

6.1.2 All standing rigging shall be attached to the gunter mast by being looped over the top of the mast not more than 50mm from its top. A plastic or GRP cap to protect the gunter mast from the rigging is permitted.

6.1.3 The forestay shall be attached to the forestay attachment fitting. The method of attachment is optional.

6.1.4 Each shroud shall be attached to a shroud attachment fitting. The method of attachment is optional but Highfield levers are not permitted.

6.1.5 The shroud tension and the length of the shrouds and forestay shall not be altered while racing.

### 6.2 **Running Rigging**

6.2.1 The type and material of running rigging and associated fittings are optional subject to the following limitations:

- (i) Main and jib halyards must be made fast on the mast below the gooseneck. The main halyard may be tightened using a 2:1 purchase. No other mechanical advantage may be used to tighten either halyard.
- (ii) The mainsheet shall have a maximum of 5 turning blocks. The mainsheet or turning blocks shall be attached to the transom, via the mainsheet attachment points only, inside the cockpit adjacent to the thwart, or on the boom. If the mainsheet runs along the exterior of the boom it shall pass through at least one constraining loop or sleeve that does not protrude more than 50 mm from the surface of the boom.
- (iii) There may be one ratchet block for use in the mainsheet system only.
- (iv) The kicking strap shall have a purchase not greater than 8:1.

OR

The kicking strap shall be a gnav strut arrangement with a control line purchase of not more than 8:1. The angle of the lower edge of the strut to the upper edge of the **boom** shall not be greater than 45°, measured with the boom at 90° to the aft edge of the **mast spar**.

- (v) Other apparatus which controls mast bend is prohibited.

## Section 7 – Sails

### 7.1 PARTS

#### 7.1.1 MANDATORY

- (a) Mainsail
- (b) Headsail

#### 7.1.2 OPTIONAL

- (a) Spinnaker

### 7.2 GENERAL

#### 7.2.1 RULES

- (a) **Sails** shall comply with the **class rules** in force at the time of **certification**.

#### 7.2.2 CERTIFICATION

- (a) The **official measurer** shall **certify** mainsails and headsails in the **tack** and spinnakers in the **head** and shall sign and date the **certification mark**.
- (b) An MNA may appoint one or more persons at a sailmaker to measure and **certify sails** produced by that manufacturer in accordance with the ISAF In-house Certification Guidelines.

#### 7.2.3 DEFINITIONS

- (a) LMP Luff Measurement Point – the point on the mainsail **luff** 1245mm from the **tack point**.

#### 7.2.4 SAILMAKER

- (a) No licence is required.

#### 7.2.5 LIMITATIONS

- (a) Not more than 1 mainsail, 1 jib and 1 spinnaker shall be carried aboard.
- (b) Not more than 1 mainsail, 1 jib and 1 spinnaker shall be used during an event of less than 14 consecutive days, except when a **sail** has been lost or damaged beyond repair.

### 7.3 MAINSAIL

#### 7.3.1 IDENTIFICATION

- (a) The class insignia shall conform to the dimensions and requirements, and be placed in accordance with the diagram contained in Part C – Class Insignia. The insignia may be placed back to back, if placed back to back the points of the insignia shall point towards the leech.
- (b) The full boat/plaque number shall be carried.
- (c) The insignia, letters and numbers shall be black.

#### 7.3.2 MATERIALS

- (a) The **ply** fibres shall consist of woven polyester.
- (b) **Sail reinforcement** shall consist of materials as permitted in the **body of the sail**.
- (c) The colour of the **ply** shall be red within the range of Pantone Warm Red and its derivatives 179, 185, 187, 192, 193, 200 and 201, of the Pantone Colour Formula Guide 747XR.
- (d) **Tabling** on the **luff** may be white.

#### 7.3.3 CONSTRUCTION

- (a) The construction shall be: **soft sail, single ply sail**.
- (b) The **body of the sail** shall consist of the same **woven ply** throughout.
- (c) All panel plies shall run from **leech** to **luff**, or **leech** to **foot**, or **leech** to **luff** and **foot**.

- (d) At least one **seam** shall intersect the **leech** within 1000mm of the **half leech point**
- (e) The **sail** shall have three (3) **batten pockets** in the **leech**. The intersection of the centreline of each **batten pocket** and the **leech** shall be within  $\pm 50$ mm of the **quarter, half and three-quarter leech points**.
- (f) The following are permitted: Stitching, glues, webbing, woven tapes, bolt ropes on the **luff**, corner eyes, luff lacing eyes, **batten pocket patches**, batten pocket elastic, batten pocket end caps, batten retaining devices, **windows**, tell tales and items as permitted or prescribed by other applicable *rules*.
- (g) The **leech** shall not extend aft of straight lines between:
- (1) the **aft head point** and the intersection of the **leech** and the upper edge of the nearest **batten pocket**,
  - (2) the intersection of the **leech** and the lower edge of a **batten pocket** and the intersection of the **leech** and the upper edge of an adjacent **batten pocket** below,
  - (3) the **clew point** and the intersection of the **leech** and the lower edge of the nearest **batten pocket**.
- (h) The shape of the **foot** shall be convex.
- (i) Not more than three **tucks** or **darts** are permitted along the **foot**, and these shall not touch the **seam** of the next panel nor exceed a maximum length of 360 mm.
- (j) **Double luff sails** are prohibited.
- (k) There may be a maximum of six (6) eyelets in the **luff** below the LMP.
- (l) There may be not more than one corner eye at the **head**, one at the **tack** and one at the **clew**.
- (m) The number of **windows** is not restricted.

#### 7.3.4 DIMENSIONS

	minimum	maximum
<b>Leech length</b>	-	4520 mm
<b>Luff length</b>	-	4052 mm
<b>Foot length</b>	-	2135 mm
<b>Foot median</b>	-	4340 mm
<b>Upper width at upper leech point</b> 1067 mm from <b>head point</b>	-	725 mm
<b>Top width</b>	-	55 mm
<b>Primary reinforcement</b>	-	271 mm
<b>Secondary reinforcement:</b>		
from <b>sail corner measurement points</b>	-	813 mm
for <b>flutter patches</b>	-	100 mm
for <b>chafing patches</b>	-	750 mm
for <b>batten pocket patches</b>	-	150 mm
<b>Tabling width</b>	-	30 mm
Length of boltrope from the <b>head point</b>	2810 mm	-
<b>Half leech point</b> to LMP	-	1650 mm
Distance from <b>clew point</b> to LMP	-	2530 mm
<b>Batten pocket length:</b>		
uppermost pocket:		
<b>inside</b>	-	560 mm
intermediate and lowermost pockets:		
<b>inside</b>	-	660 mm



	minimum	maximum
<b>Batten pocket width:</b>		
<b>inside</b>	32 mm	60 mm
<b>Window to luff</b>	250 mm	
<b>Window to leech</b>	800 mm	
<b>Window to foot</b>		500 mm

### 7.3.5 USE

- (1) The **sail** shall be hoisted on a halyard. The arrangement shall permit hoisting and lowering of the **sail** whilst afloat.
- (2) The highest visible point of the **sail**, projected at 90° to the mast **spar**, shall not be set above the lower edge of the mast **upper limit mark**. For boats equipped with a gunter rig, the highest visible point of the **sail**, projected at 90° to the gaff shall not be set above the lower edge of the gaff measurement band. The intersection of the **leech** and the top of the boom **spar**, each extended as necessary, shall not be behind the fore side of the boom **outer limit mark**.
- (3) The **sail** shall be loose footed.

## 7.4 HEADSAIL

### 7.4.1 MATERIALS

- (a) The **ply** fibres shall consist of woven polyester.
- (b) **Sail reinforcement** shall consist of materials as permitted in the **body of the sail**.
- (c) The colour of the **ply** shall be red within the range of Pantone Warm Red and its derivatives 179, 185, 187, 192, 193, 200 and 201, of the Pantone Colour Formula Guide 747XR.
- (d) **Tabling** on the **luff** may be white.

### 7.4.2 CONSTRUCTION

- (a) The construction shall be: **soft sail, single ply sail**.
- (b) The body of the sail shall consist of the same woven ply throughout.
- (c) Except in the lowermost panel, all other panel plies shall extend from **leech** to **luff**, or **leech** to **foot**, or **leech** to **luff** and **foot**. One seam passing through the **foot** is permitted in the lowermost panel.
- (d) At least one **seam** shall intersect the **leech** within 1000mm of the **half leech point**
- (e) Not more than three tucks or darts are permitted along the foot, and these shall not touch the seam of the next panel nor exceed a maximum length of 360 mm.
- (f) The **leech** shall not extend beyond a straight line from the aft **head point** to the **clew point**.
- (g) **Double luff sails** are prohibited.
- (h) The following are permitted: Stitching, glues, webbing, woven tapes, corner eyes, hanks and associated eyes, one **window**, tell tales, and items as permitted or prescribed by other applicable *rules*.
- (i) There shall be not more than one attachment point at the **head**, one at the **tack** and one at the **clew**.

### 7.4.3 DIMENSIONS

	minimum	maximum
<b>Luff length</b>	-	2782 mm
<b>Leech length</b>	-	2442 mm

	minimum	maximum
<b>Foot length</b>	-	1540 mm
<b>Foot median</b>	-	2545 mm
<b>Top width</b>	-	35 mm
<b>Primary reinforcement</b>	-	234 mm
<b>Secondary reinforcement:</b>		
from <b>sail corner measurement points</b>	-	702 mm
for <b>flutter patches</b>	-	100 mm
for <b>chafing patches</b>	-	750 mm
<b>Tabling width</b>	-	30 mm
<b>Window dimension in any direction</b>	-	460 mm
<b>Window to sail edge</b>	125 mm	-

## 7.5 SPINNAKER

### 7.5.1 IDENTIFICATION

- (a) RRS appendix G1.1 is amended so that national letters are optional.
- (b) RRS appendix G1.1 is amended so that the full boat/plaque number is optional.

### 7.5.1 MATERIALS

- (a) The **ply** fibres shall consist of woven nylon.
- (b) **Sail reinforcement** shall consist of woven polyester or woven nylon.

### 7.5.2 CONSTRUCTION

- (a) The construction shall be: **soft sail, single ply sail.**
- (b) The **body of the sail** shall consist of the same **woven ply** throughout.
- (c) The following are permitted: Stitching, glues, tapes, corner eyes, recovery line patches, recovery line attachment point or eye and items as permitted or prescribed by other applicable *rules*.
- (d) The **sail** shall be symmetrical about its centreline
- (e) The **sail** shall be made of not more than eight panels and may be of any colour or combination of colours.
- (f) All panel plies shall extend from **luff** to **leech**.
- (g) The colour of any **tabling** and reinforcement is optional.

### 7.5.3 DIMENSIONS

	minimum	maximum
<b>Leech lengths</b>	2700 mm	2820 mm
<b>Foot length</b>	-	2286 mm
<b>Foot Median</b>	-	3490 mm
<b>Half width</b>	-	2220 mm

## 8. CREW

Except when otherwise specified in the sailing instructions there shall be two persons on board while racing.

## 9. PROHIBITIONS

9.1 The use of any apparatus or contrivance outboard or extending outboard, of the gunwale the purpose of which is or may be to support or assist in supporting the crew outboard.

9.2 Electronic and electrical instruments with the exception of electronic timing devices.

## 10 ADVERTISING

Advertising in accordance with ISAF Regulation 20 is permitted, however as per regulation 20.5 competitor advertising on the hull and sails are limited as follows -

10.1 No advertising on jib.

10.2 Advertising on mainsail is limited to within 500mm of the **foot**.

10.3 Advertising on the hull is limited to the central 50% of the hull length.

PART C – CLASS INSIGNIA

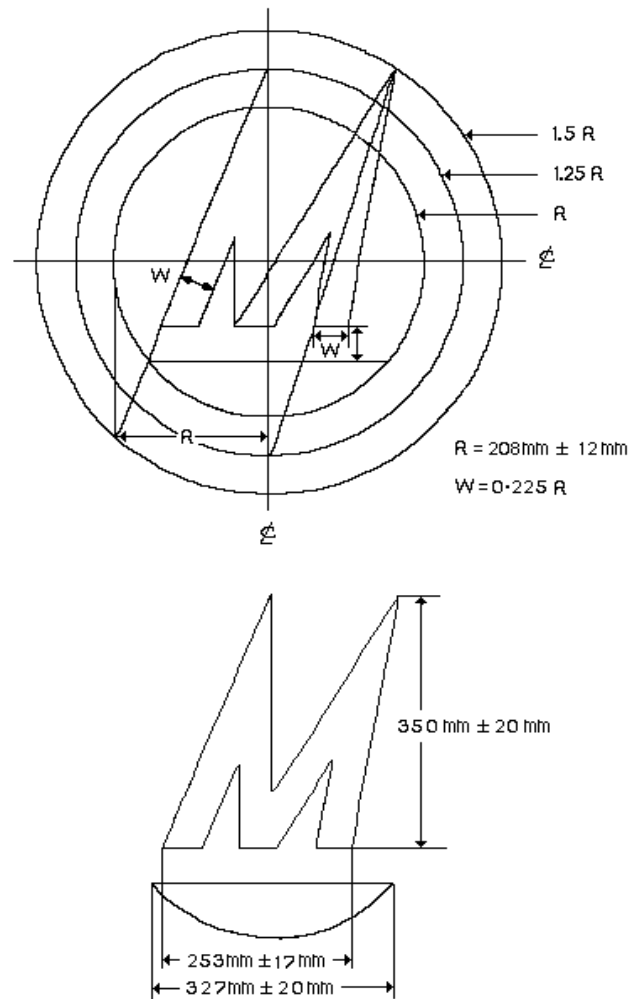

The dimensions are changed to  $W=0.225R$  minimum and  $0.40R$  maximum.  
 Height of  $M= 350\text{mm} \pm 25\text{mm}$  and the width of Half Moon  $M=327 \pm 65\text{mm}$ .

© ISAF (UK) Ltd., Southampton, UK

Effective Date: 17<sup>th</sup> September 2010  
 Published Date: 22<sup>nd</sup> September 2010  
 Previous Issue: 20<sup>th</sup> November 2008

**NOTE** For these Rules the ISAF have defined "hull panels" as including the following parts:-

- |                   |                       |
|-------------------|-----------------------|
| Aft Bottom Panel  | Forward Bottom Panel  |
| Aft Topside Panel | Forward Topside Panel |
| Aft Transom Unit  | Forward Transom       |
| Stowage Bulkhead  | Mast Web              |
| Forward Bulkhead  | Aft Bulkhead          |
| Side Tank Side    | Forward Deck          |
| Side Deck         | Aft Deck              |
| Skeg              | Side Tank Stiffener   |